

Reminders

1. Two people are needed for assembly.
2. Use only the hardware supplied.
3. Do not over-tighten bolts.
4. This item may require periodic tightening.

WINNERS ONLY®

ASSEMBLY INSTRUCTIONS

PROD NO: DV2470BN

IMPORTANT NOTE:

Please keep all hardware parts out of the reach of children.

STEP 1

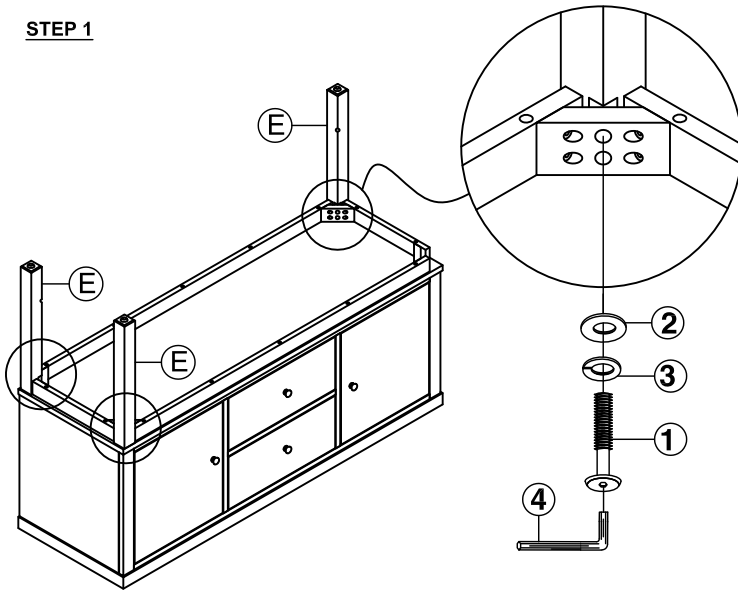

STEP 2

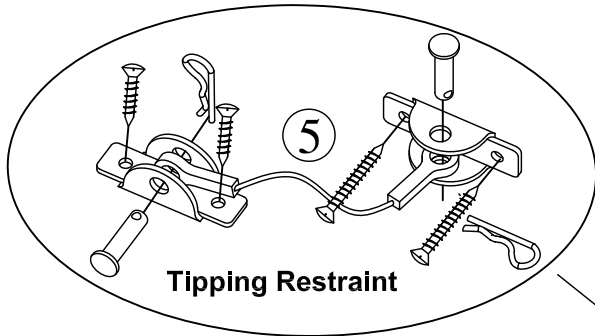
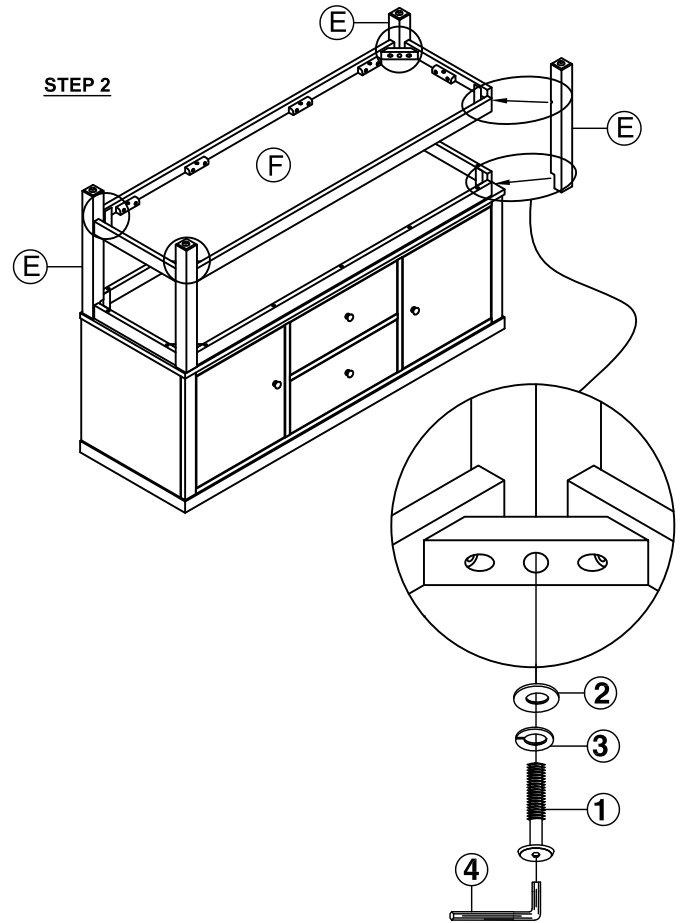

Tipping Restraint

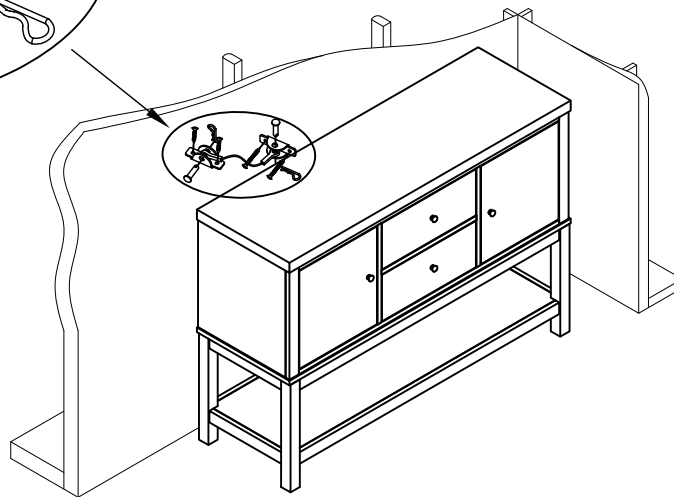

NOTE
Tipping restraint hardware is included with this product. Refer to installation instruction in the hardware pack.







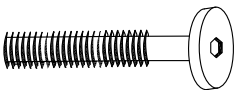
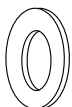

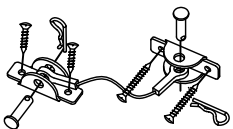
Thank you for purchasing this quality product. Be sure to check all packing material carefully for small parts that may have come loose inside the carton during shipment.

1 OF 2

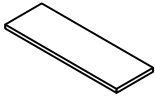
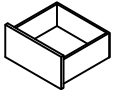
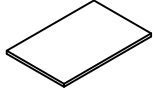
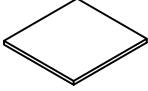
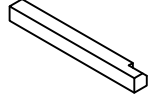
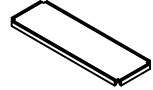
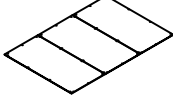
MADE IN VIETNAM

<p>① Bolt</p>  <p>12 PCS</p>	<p>② Flat Washer</p>  <p>12 PCS</p>	<p>③ Lock Washer</p>  <p>12 PCS</p>	<p>④ Allen Key</p>  <p>1PC</p>
<p>⑤ Anti-Tipping Hardware</p>  <p>1 SET</p>			

Components List

PART NO	FIGURE	DESCRIPTION	QTY
A		Sideboard Top	1pc
B		Drawer	2pcs
C		Door Frame	2pcs
D		Wood Shelf	2pcs
E		Leg	4pcs
F		Bottom Shelf	1pc
G		Back panel	3pcs
H		Handle	4pcs
I		Bolt	4pcs
J		Shelf Clips	8pcs
K		Plastic Glide	4pcs
L		Side Door Hinge	4pcs

