







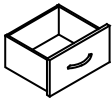

Assembly Instructions

A1-NP154B- -O

SERVER

PARTS LIST

PART NO	FIGURE	DESCRIPTION	QTY
A1-NP154B-01 / A1-NP154B-01		Hardware Bag	1 pce
A1-NP154B-16 / A1-NP154B-16		Table Top	1 pce
A1-NP154B-04 / A1-NP154B-04		Drawer	3 pcs
A1-NP154B-06 / A1-NP154B-06		Door Glass	2 pcs
A1-NP154B-07 / A1-NP154B-07		Glass Shelf	4 pcs
A1-NP154B-20 / A1-NP154B-20		Handle	5 pcs
A1-NP154B-30 / A1-NP154B-30		Plastic Nail	2 pce
A1-NP154B-22 / A1-NP154B-22		Levelers	3 pcs
A1-NP154B-29 / A1-NP154B-29		Center Bun Foot	1 pce

IMPORTANT NOTE : Please keep all hardware parts out of the reach of children.

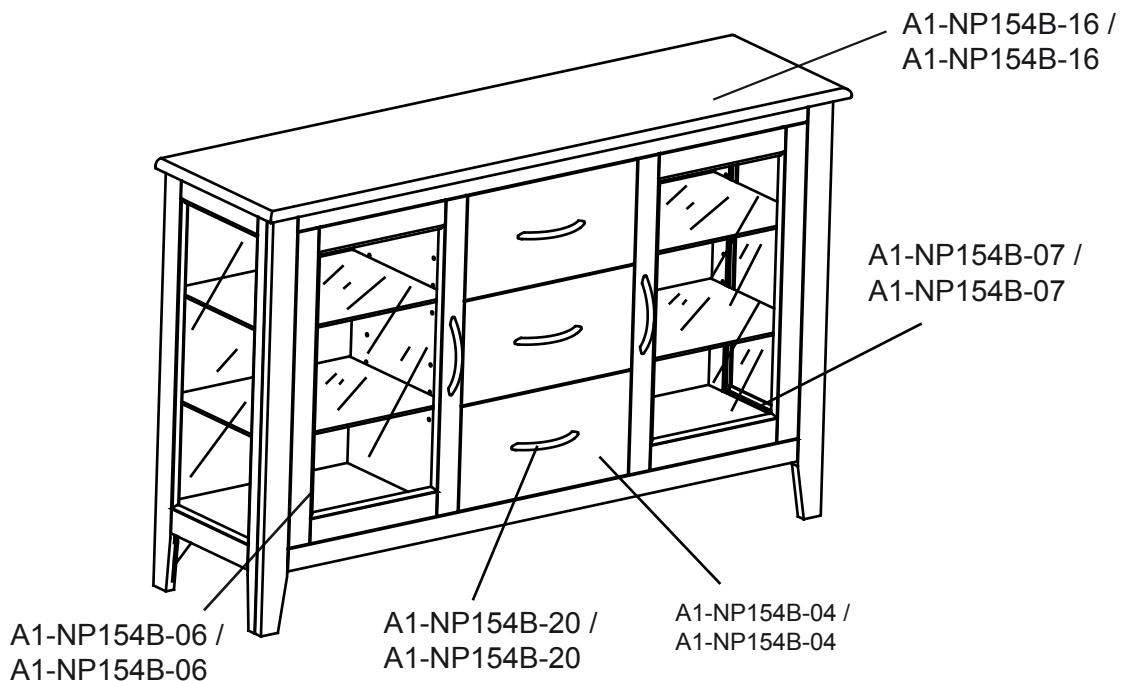

Assembly Instructions

A1-NP154B- -O

SERVER

Reminders :

- Two people are needed for assembly.
- Use only hardware supplied.
- Do not over tighten bolts.
- This item may require periodic tightening.

HARDWARE PART :



ASSEMBLY :

STEP 1

Insert support leg to the bottom of the sideboard as shown on Fig1. Insert the shelf pin supporter into the server and place glass shelf on them as shown on Fig.1

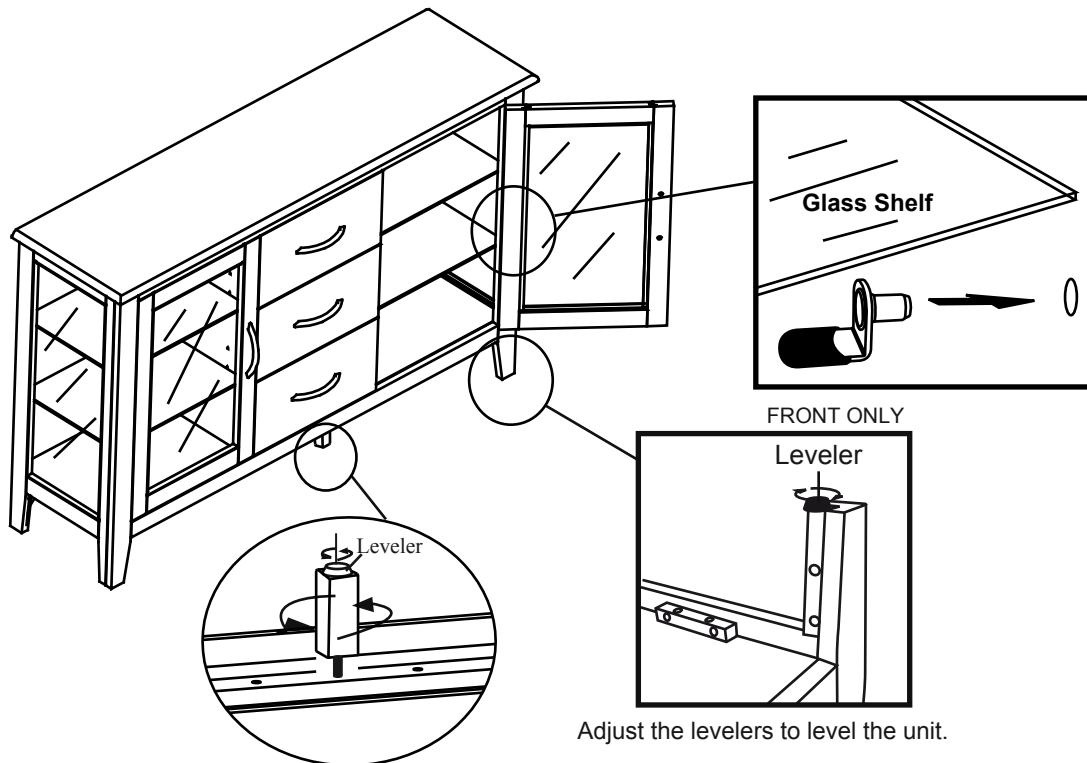

STEP 2

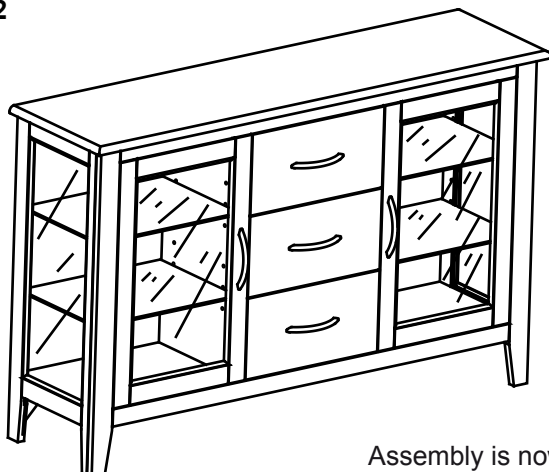

Assembly is now Completed.

IMPORTANT NOTE :

~ Please keep all hardware out of the reach of children.

CARE INSTRUCTION

- ~ Be sure to use the same type of polish consistently. Your furniture will appear cloudy or streaky if oil based or wax based polishes are interchanged.
- ~ Spray your furniture surface evenly. Wipe in a circular motion with a soft clean cloth.